

# TECU® Master Seams

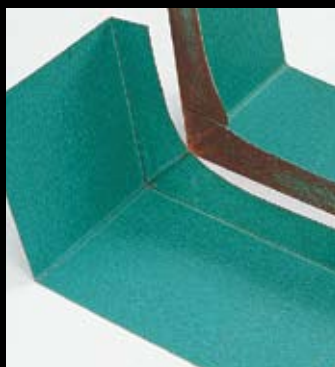

KME Germany AG & Co. KG  
TECU® Master Seams [GB]

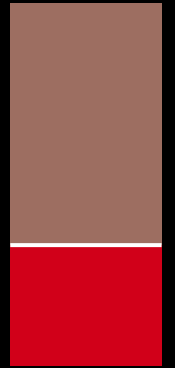

Single lock cross welt, roof pitch  $\geq 25^\circ$

- 3** Double lock cross welt, roof pitch  $\geq 7^\circ$
- 5** Splayed edge standing seam
- 7** Squared edge standing seam
- 9** Swabian eaves
- 11** Curved eaves standing seam
- 13** Pinched seam
- 15** Sweep
- 17** Straight dog-eared upstand, preformed
- 19** Straight dog-eared upstand
- 21** Tools
- 23** TECU® Training Center
- 24** TECU® Service

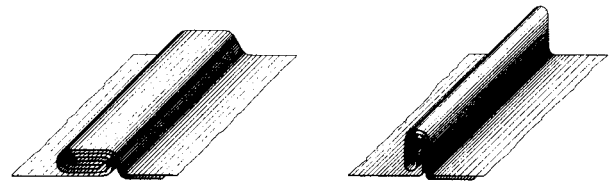

# TECU<sup>®</sup> Master Seams for traditional and modern seam crafting techniques

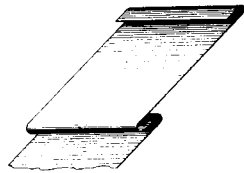
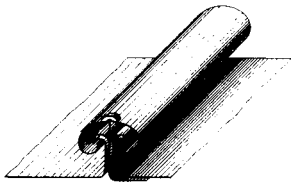

The physical appearance of sheet metal work is determined by the seam, which connects individual sheets or trays to each other (*see illustrations*).

In the history of construction, it is quite likely that seaming techniques are just as old as the techniques for processing copper sheets. The roof of the cathedral in Hildesheim, Germany, parts of which were built as early as 1280, displays the classic characteristics of seamed roofing (*see illustrations*). The seam was so technically perfect right from its very conception – as its continued use through the centuries clearly proves – that it remains today the basis for modern applications of metalworking.

The Baroque period (especially in continental Europe) saw the introduction of a great variety of forms and can be seen as the first development of copper roofing and the copper smith's craftsmanship. Since then, numerous modifications of the original standing seam have been developed, as depicted in a trade reference book from the turn of the century (*see illustrations*).

The seaming technique makes possible the fixing of the trays, which are pre-formed and installed in either sheets or strips. The seam itself connects the trays, which are fixed to the substrate with clips that are folded within the seam. Many design possibilities can be created from this basic technique, for example by using different constructions of the seam, varying bay sizes or bay alignments. By employing standard metalworking methods to the seams, such as crimping, stretching, folding and bending, it is possible to clad practically any building structure or shape without problem.

The following diagrams show the most common seam ends. The individual working steps and cutting away for seam ends are illustrated with models. The master seams are displayed on a scale of 1:1 and may be copied, cut out and transferred to copper sheets. Paper sheets may also be used in place of metal to practice forming the master seams. Not all the steps of some seam connections can be displayed with paper since it cannot be splayed like metal sheets.

**Single lock cross welt, roof pitch  $\geq 25^\circ$   
made of TECU<sup>®</sup> copper**

**Scale 1:1**

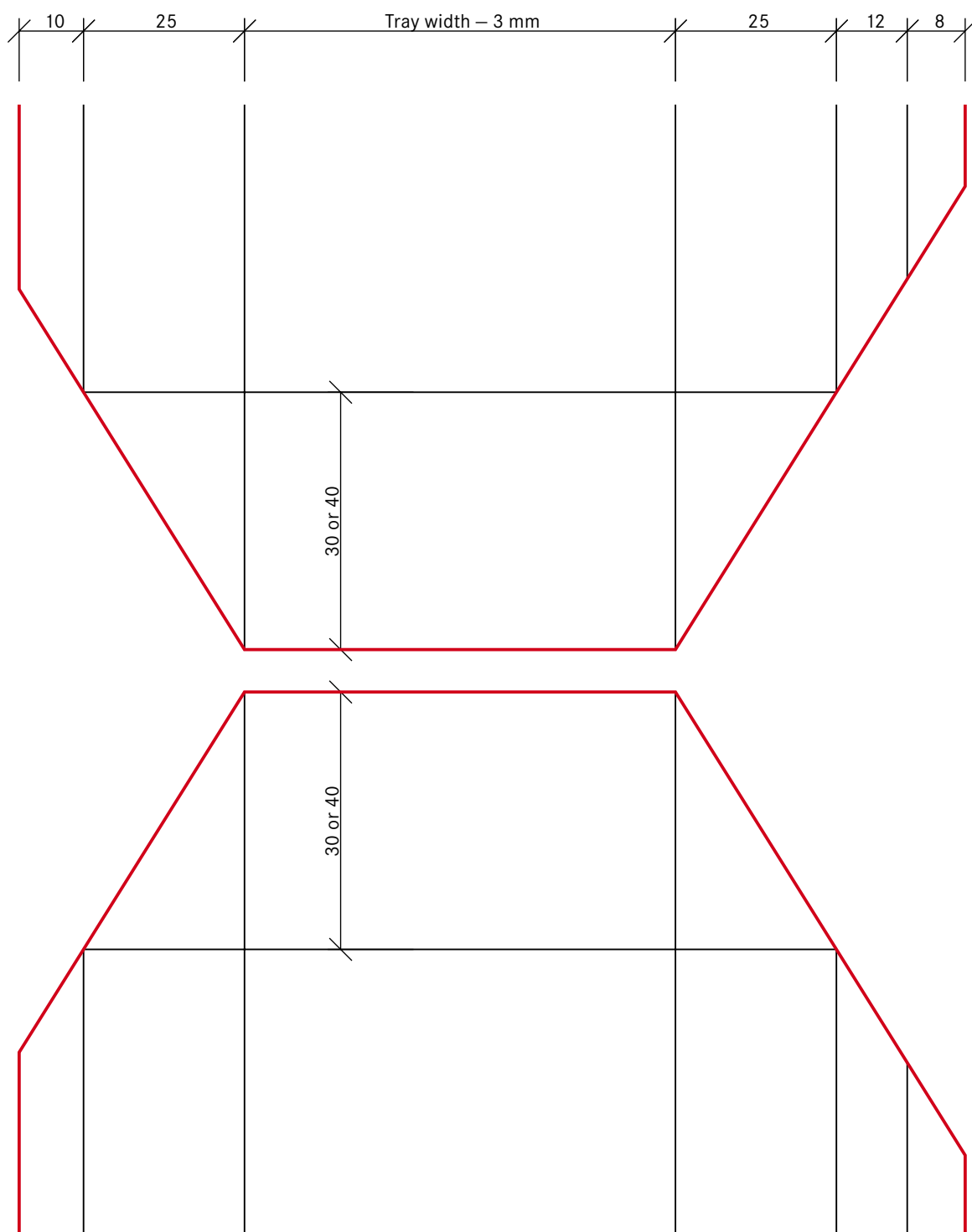

# Single Lock Cross Welt, Roof Pitch $\geq 25^\circ$

The lateral joints necessary for sheet (traditional) cladding are formed as a single lock cross welt for roof pitches of  $25^\circ$  (47 %) and over. To prevent pooling water from penetrating the single lock cross welt, either a 40 mm forward or backward fold is added at the tray end. The trays are then seamed together with an overlap of 10 mm in the finished seam.

1



Prepare the tray ends and cut away the corners.

2



Flatten the standing seam ends; fold the upper tray back and the lower tray forward by  $180^\circ$ .

3



With an overlap of 10 mm, hook the tray ends together and erect the standing seam.

4



Fold the standing seam into a double or angled welt.

**Double lock cross welt, roof pitch  $\geq 7^\circ$   
made of TECU<sup>®</sup> copper**

**Scale 1:1**

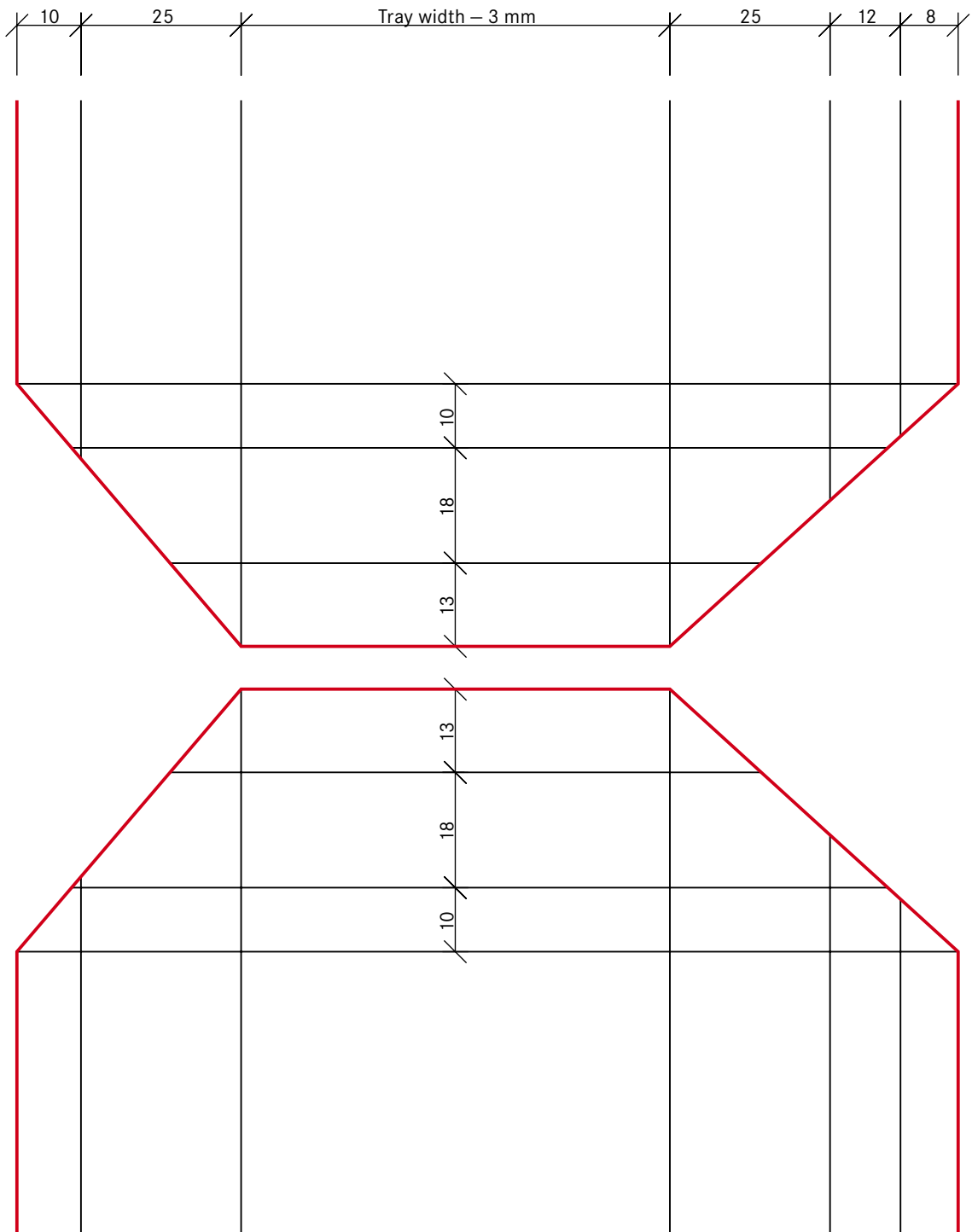

# Double Lock Cross Welt, Roof Pitch $\geq 7^\circ$

A double lock cross welt is necessary for roof pitches between  $7^\circ$  (13 %) and  $10^\circ$  (18 %). For roof pitches under  $7^\circ$  (13 %), a waterproof joint must be formed either by soldering, welding, riveting together with a sealing insert, or welting with a seal in the welt.

1

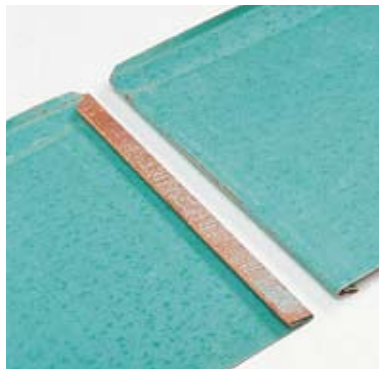

Prepare the tray ends according to the drawing and, using a 3 x 15 mm straight edge, fold ends  $180^\circ$  at 13 and 18 mm.

2



Pull the straight edge out and prepare the second tray end in the same fashion. Slide the tray ends sideways into each other.

3



Use the seaming iron to erect the standing seam.

4



Connect the standing seam to the tray parallel to it.

**Splayed edge standing seam  
made of TECU® copper**

**Scale 1:1**

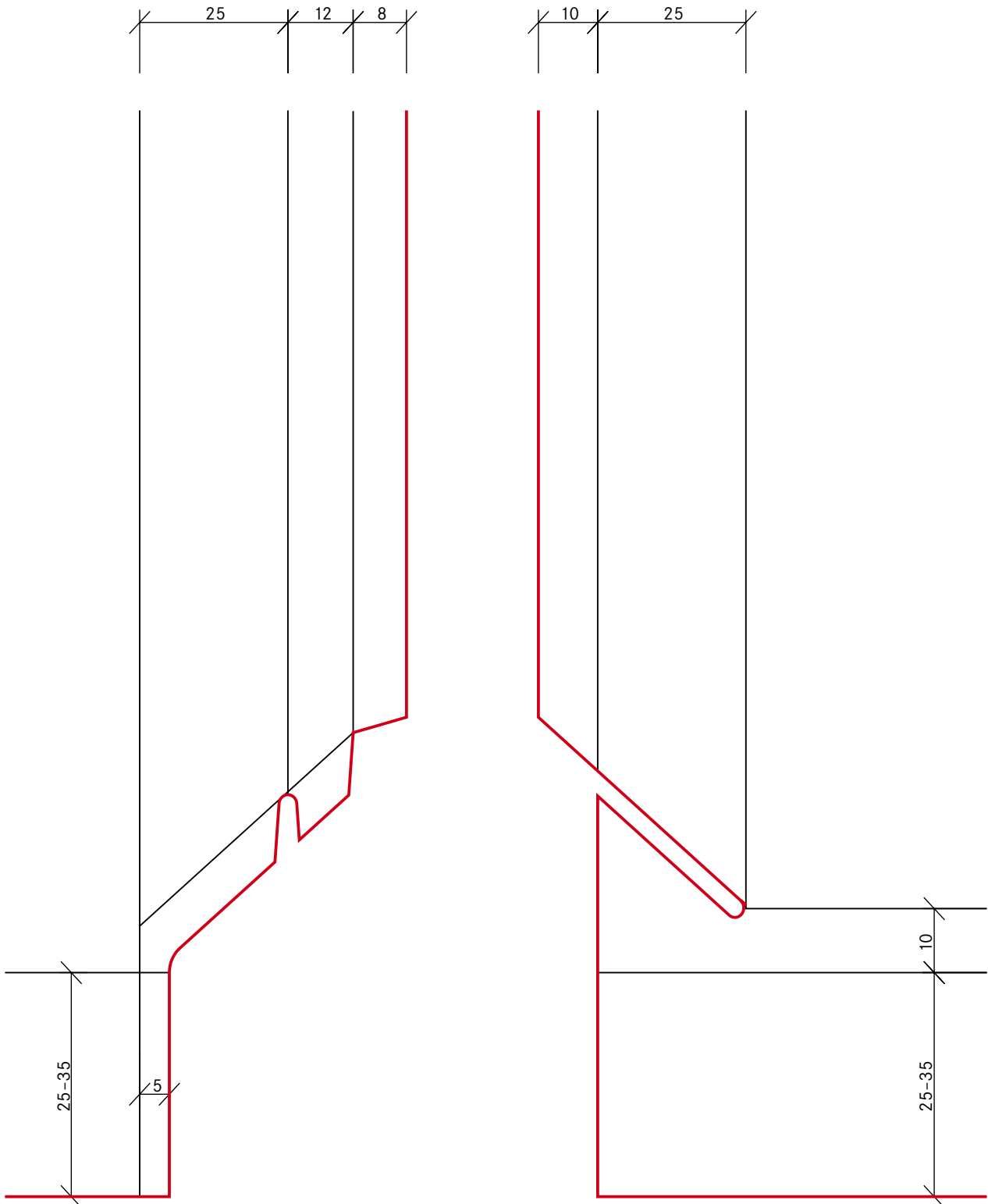



# Splayed Edge Standing Seam

This popular filigree seam connection is most often used for the eaves of a roof.

*Eaves constructions should generally be carried out with a standing seam. Flattening the seam and carrying it around the edge of the eaves would obstruct expansion across the trays. The bead on the eaves sheet should not exceed 25 mm in order to accommodate for expansion down the bays. It should be carried out with the help of a spacer, keeping at least 10 mm between the eaves sheet and the bead.*

1

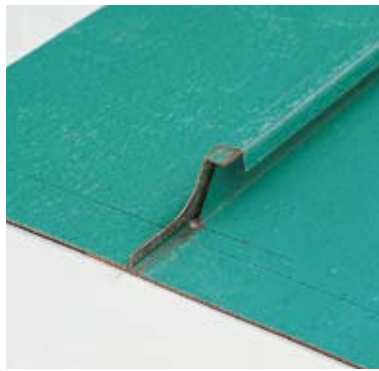

After the trays have been scribed, they are cut to size and folded.

2

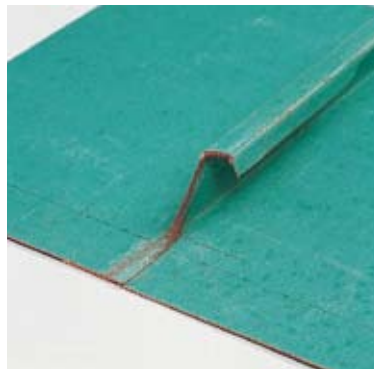

At the head end of the seam, 8-10 mm of the bead are flattened.

3



The edge of the eaves is welded under the eaves sheet using an eaves folder (first turn) and an eaves closer (second turn).

**Squared edge standing seam  
made of TECU® copper**

**Scale 1:1**

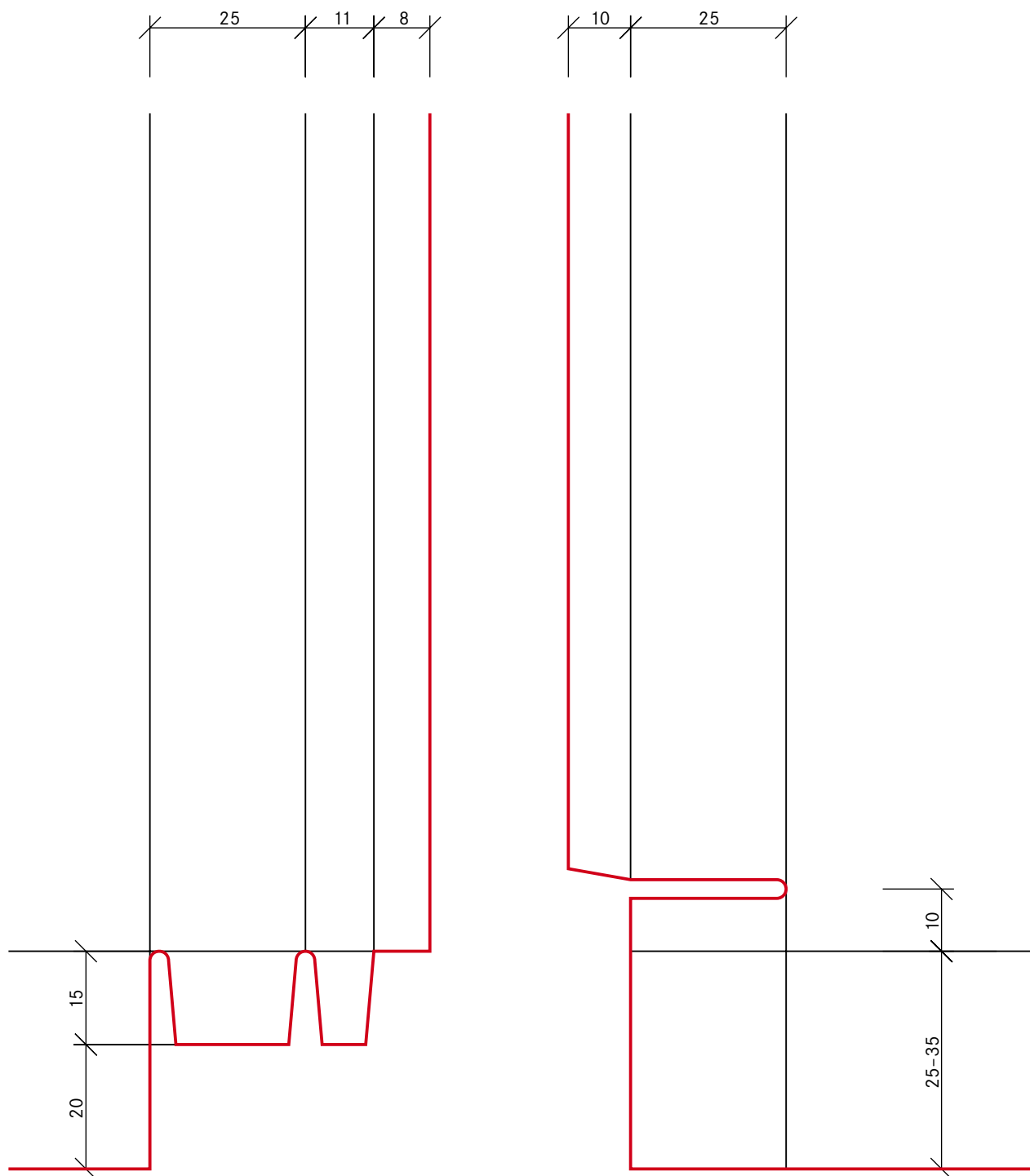

# Squared Edge Standing Seam

The squared edge standing seam type is often chosen for the ends of facade cladding and for very low pitched roofs. The foot end of the seam is „open“ to prevent rainwater run-off from being drawn in.

1

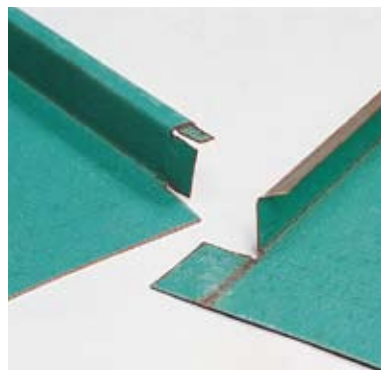

The standing double seam should be cut away at the intersection of the trays so that only the seam upstands of the overlapped tray are approx. 20 mm longer.

2

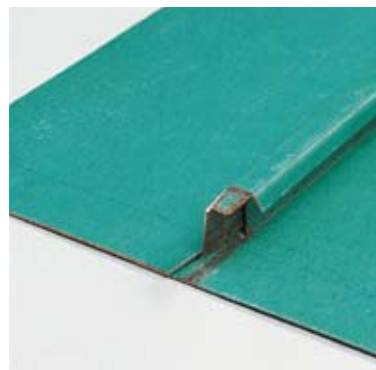

Slide the trays into each other.

3

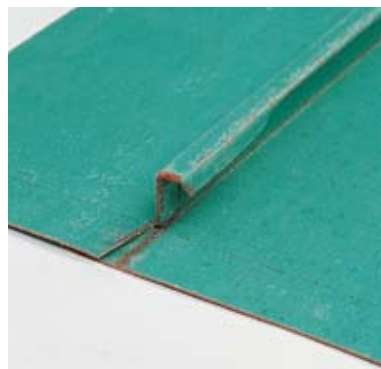

The 20 mm longer strip is then wrapped around the open end of the standing seam.

4

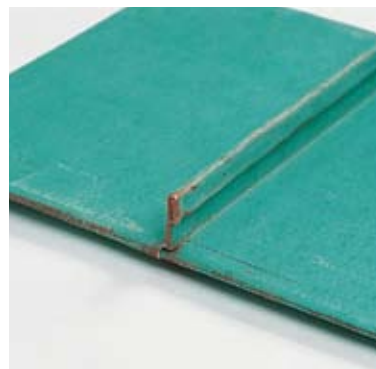

The end piece of the overlapping seam is folded back in and welded together with the tray end around the eaves flashing.

**Swabian Eaves**  
made of TECU® copper

**Scale 1:1**

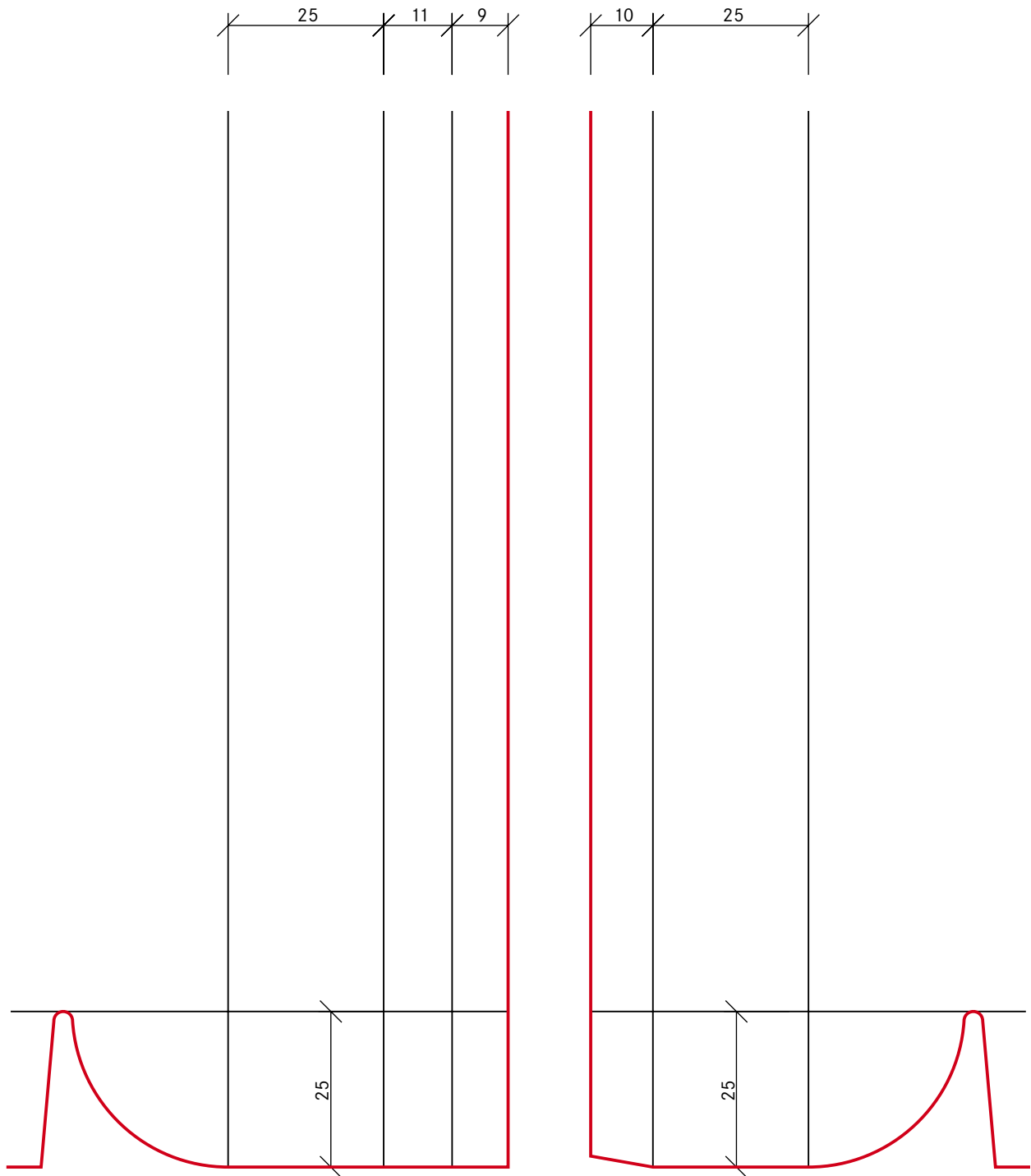

# Swabian Eaves

The standing seam is the most economical and most technically sound way of preventing capillary water from being drawn in. Swabian eaves, however, are not recommended for the ends of facade cladding because the sides of the projecting „nose“ are too easily damaged.

1

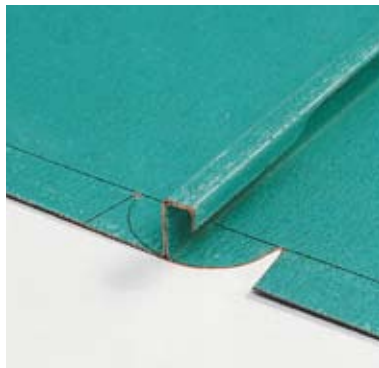

At the end of the standing seam, a quarter circle with a radius of approx. 25 mm is cut in the tray.

2



The double standing seam is formed and the end of the tray is folded around the eaves. The protruding quarter circle is folded down or crimped to create a smooth edge.

**Curved eaves standing seam  
made of TECU® copper**

**Scale 1:1**

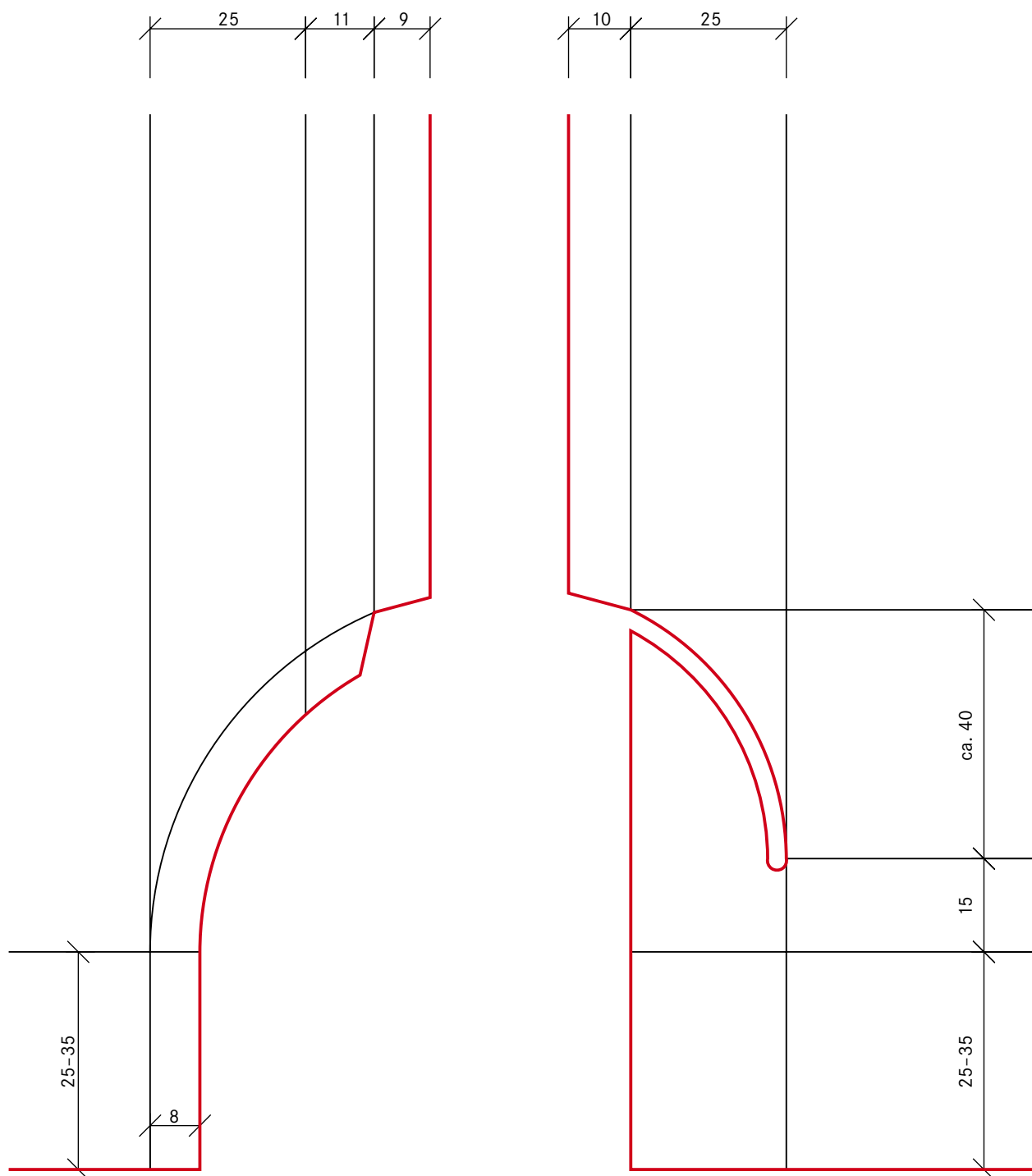

# Curved Eaves Standing Seam

The curved eaves standing seam is a very attractive technique that is especially effective for facade cladding. The seam can be produced either by hand or machine.

1

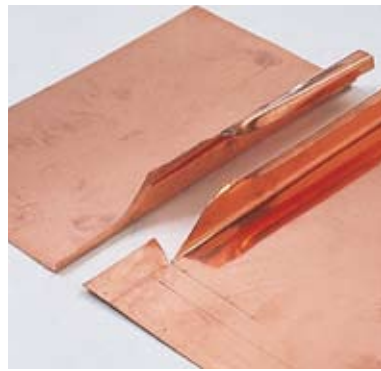

Before folding or profiling, the master pattern should be transferred to the sheet and cut out. Next, the top and bottom are slit approx. 5-8 cm.

2



The angled seam is closed just before the seam is set upright.

3



Curve and press the 8-10 mm eaves flashing closed.

4

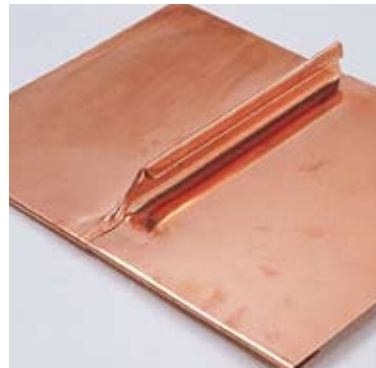

Double welt the standing seam and fold the eaves bead around the sheet.

**Pinched seam  
made of TECU® copper**

**Scale 1:1**

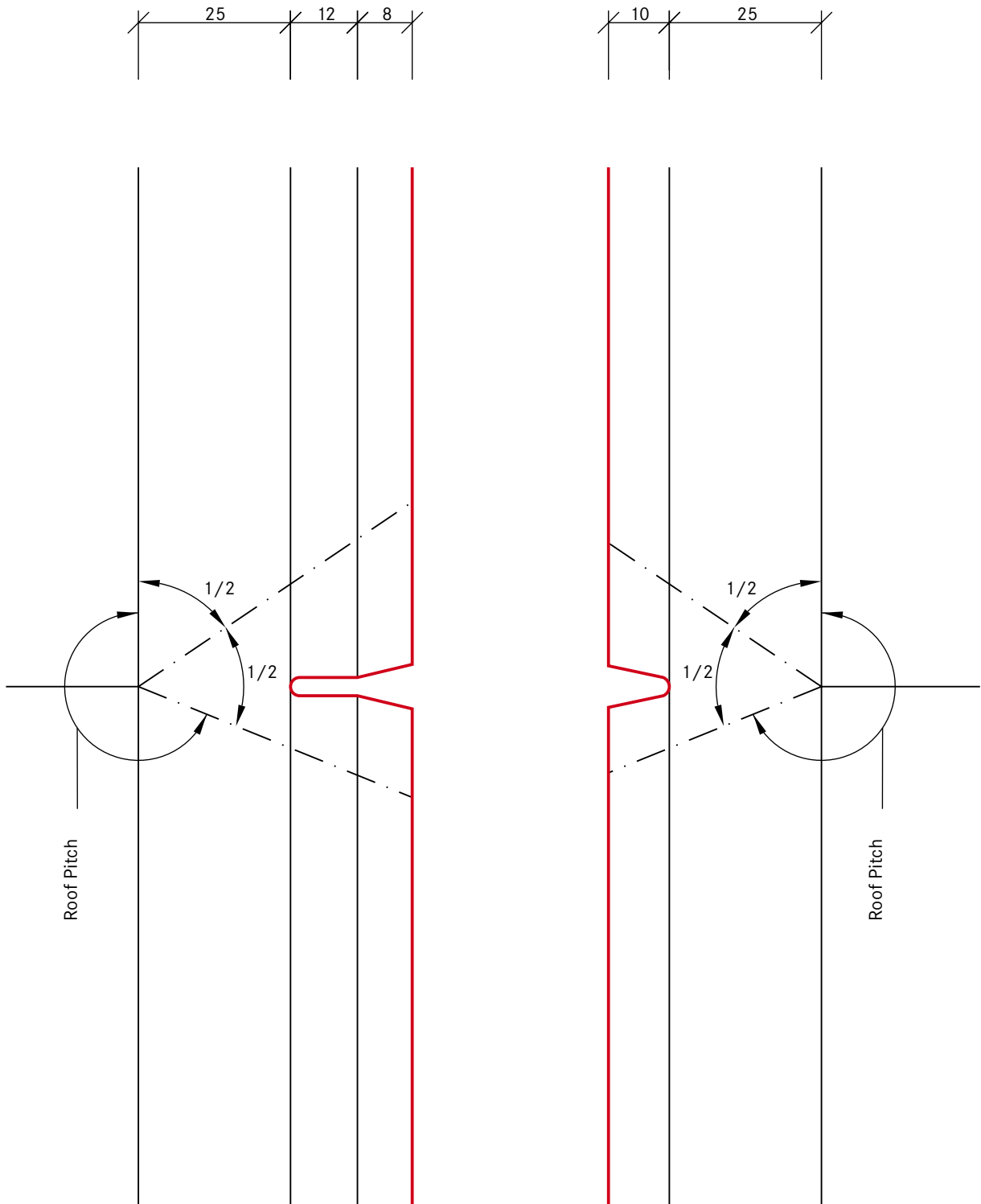



# Pinched Seam

In contrast to a semi-circular seam end, this connection does not require an extension of the seam. A cut is necessary on the lateral fold line in order to ensure that the seam is sealed only up to the finished standing seam height. The wall upstand is 150 mm. The notches, 8 mm on the bottom seam and 20 mm on the top seam, should be pre-perforated 2–4 mm so that the material does not tear after the notches have been made. The width of the cut out piece is equal to the diameter of the perforation. The pinched seam construction is depicted in the drawings below.

1



The seams are notched on the fold line and set upright. The pattern for the fold lines is to be aligned laterally and transferred onto the sheet.

2



The seams are pulled inward toward the roof along the fold lines with dog earring pliers or corner turning tongs. Then the abutment is erected on the fold line.

3



The seam on the abutment is bent back left and right against the wall and the bottom double standing seam is welted.

4



The abutment seam is repositioned and double-seamed. Be sure that the lower section of the pinched seam is not fitted tightly so that the so-called „eye“ is formed.

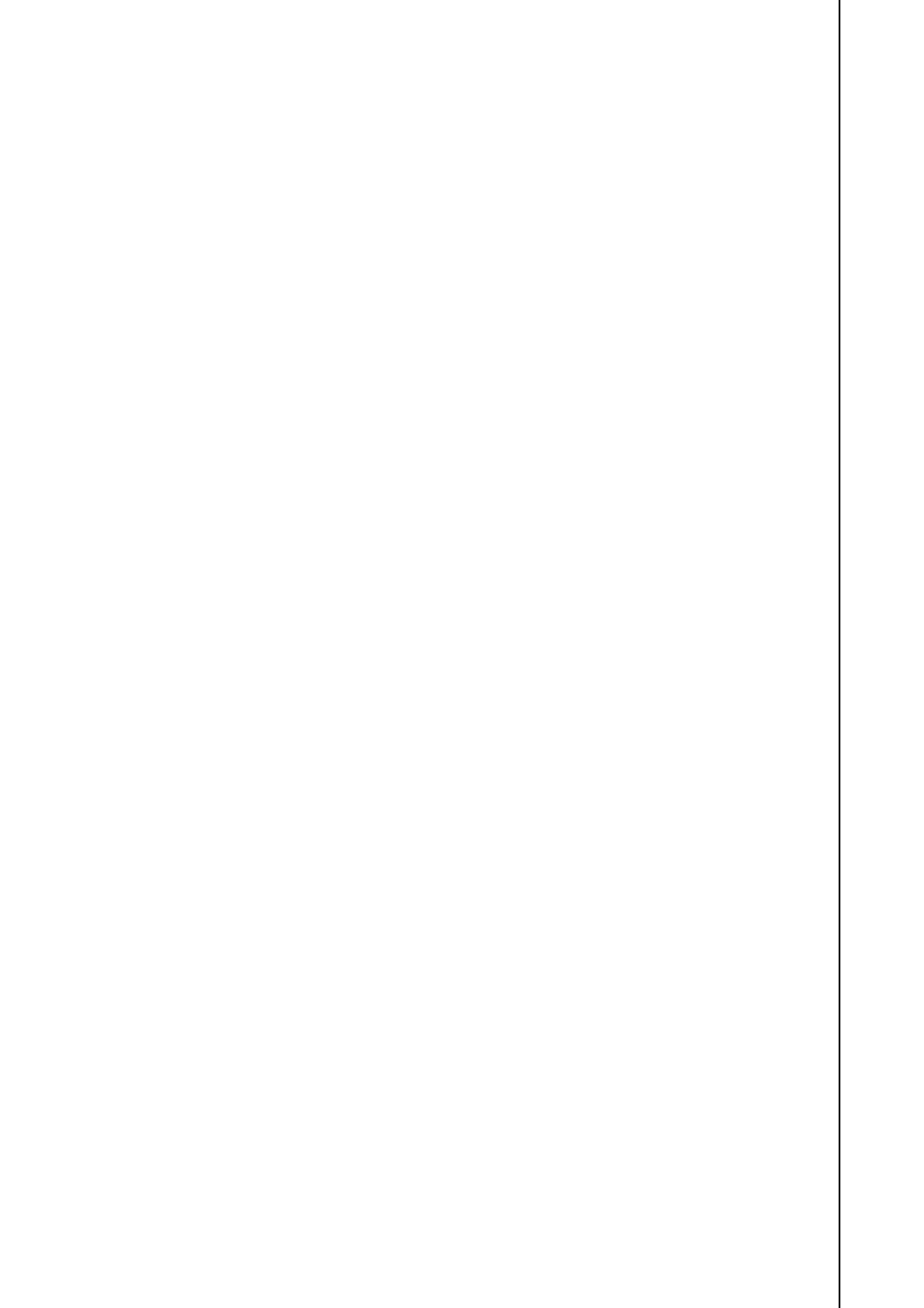

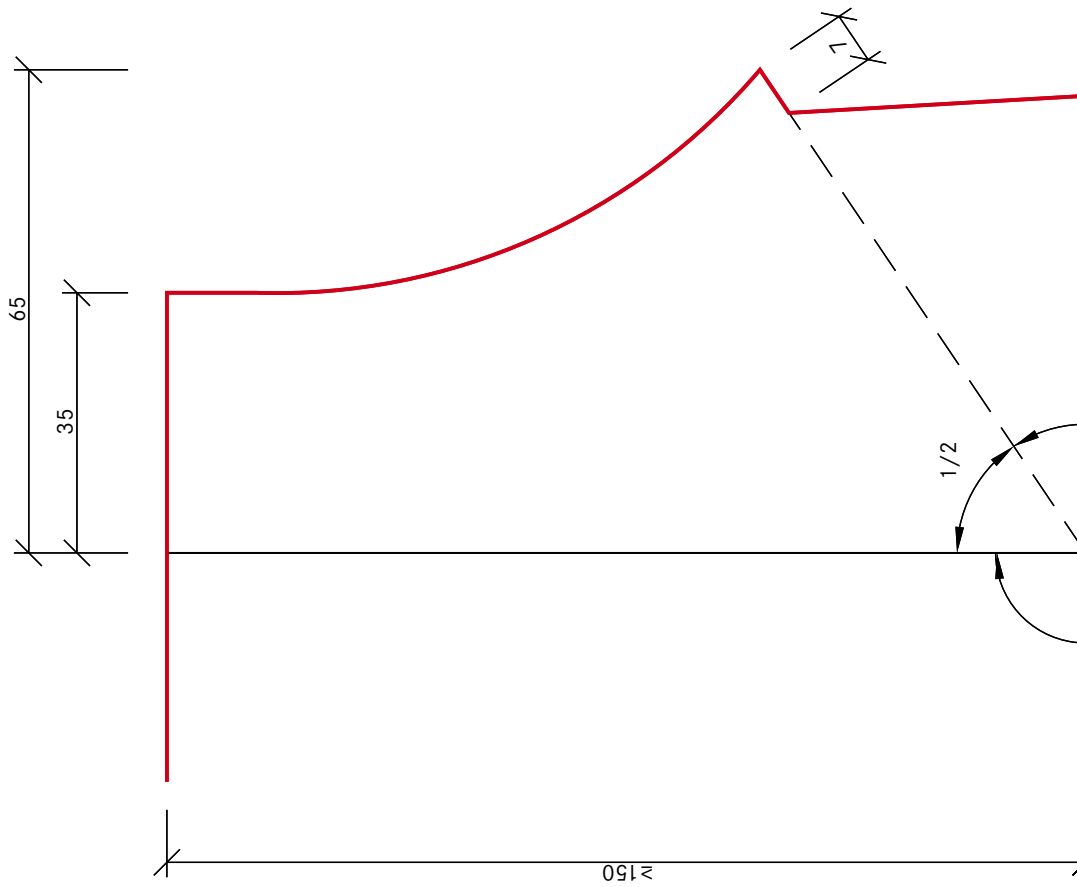
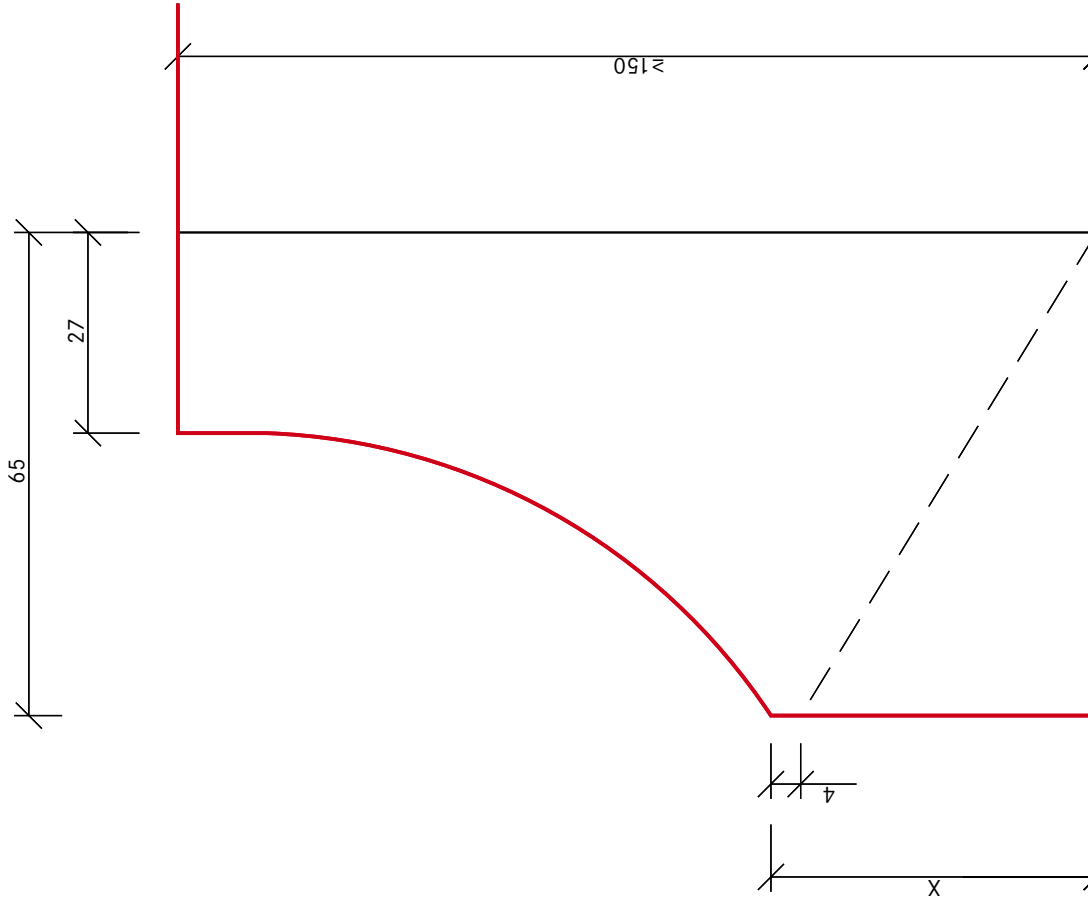

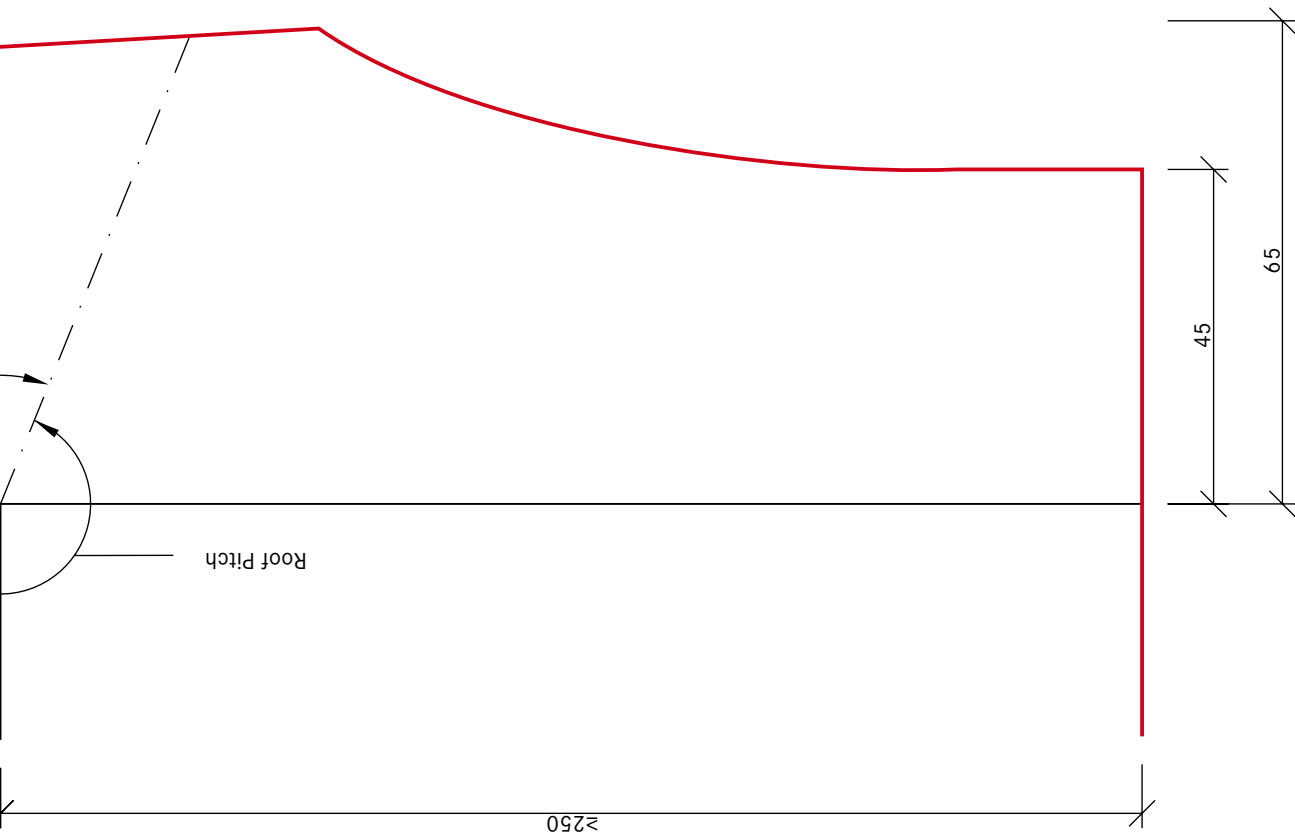
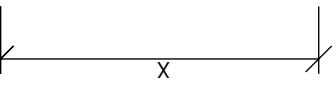
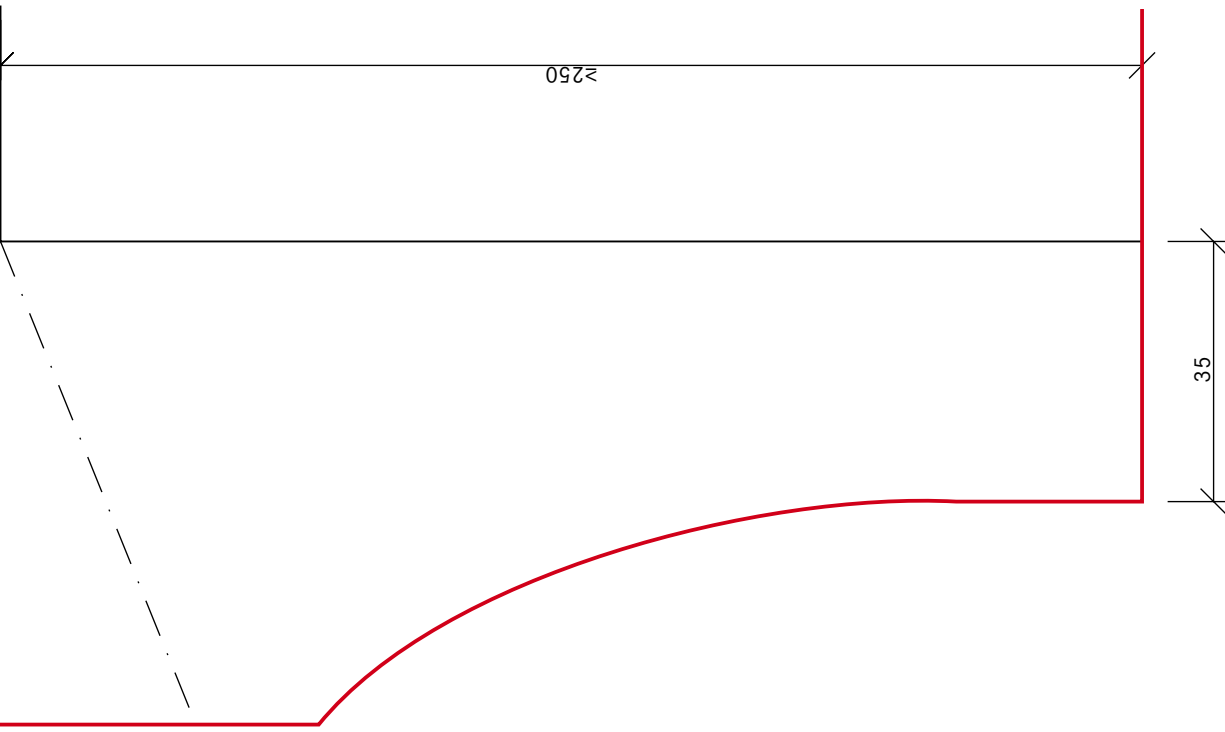

# Sweep

The sweeping pinched seam has a very elegant appearance which requires practice and good craftsmanship to produce. It is the perfect construction for roofs with low pitches as well as for flashings around chimneys.

1

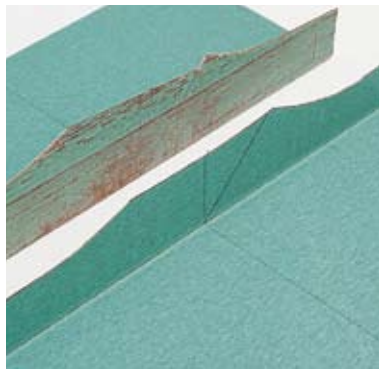

Scribe the tray on the planned fold line and cut to shape. The size of „x“ is determined by the line bisecting the angle.

2



Use the seaming iron to pull the tray up along the planned fold line and then bring it into its perpendicular position with a pair of straight large seaming pliers. In doing this, it is helpful to first crease the areas that may bulge when folded.

3

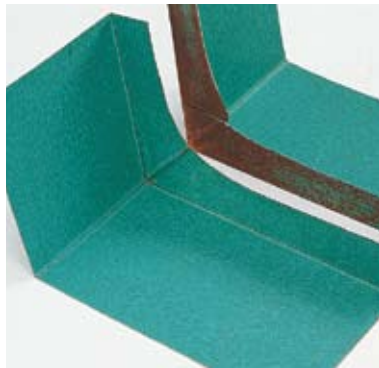

Close the pinched seam with a pair of straight large seaming pliers.

4

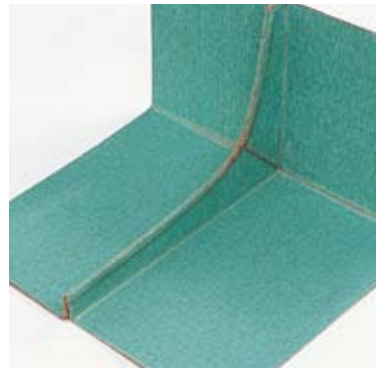

Seam the curved area using a sweep seaming hammer and a seaming iron.

**Straight dog-eared upstand, preformed,  
made of TECU® copper**

**Scale 1:1**

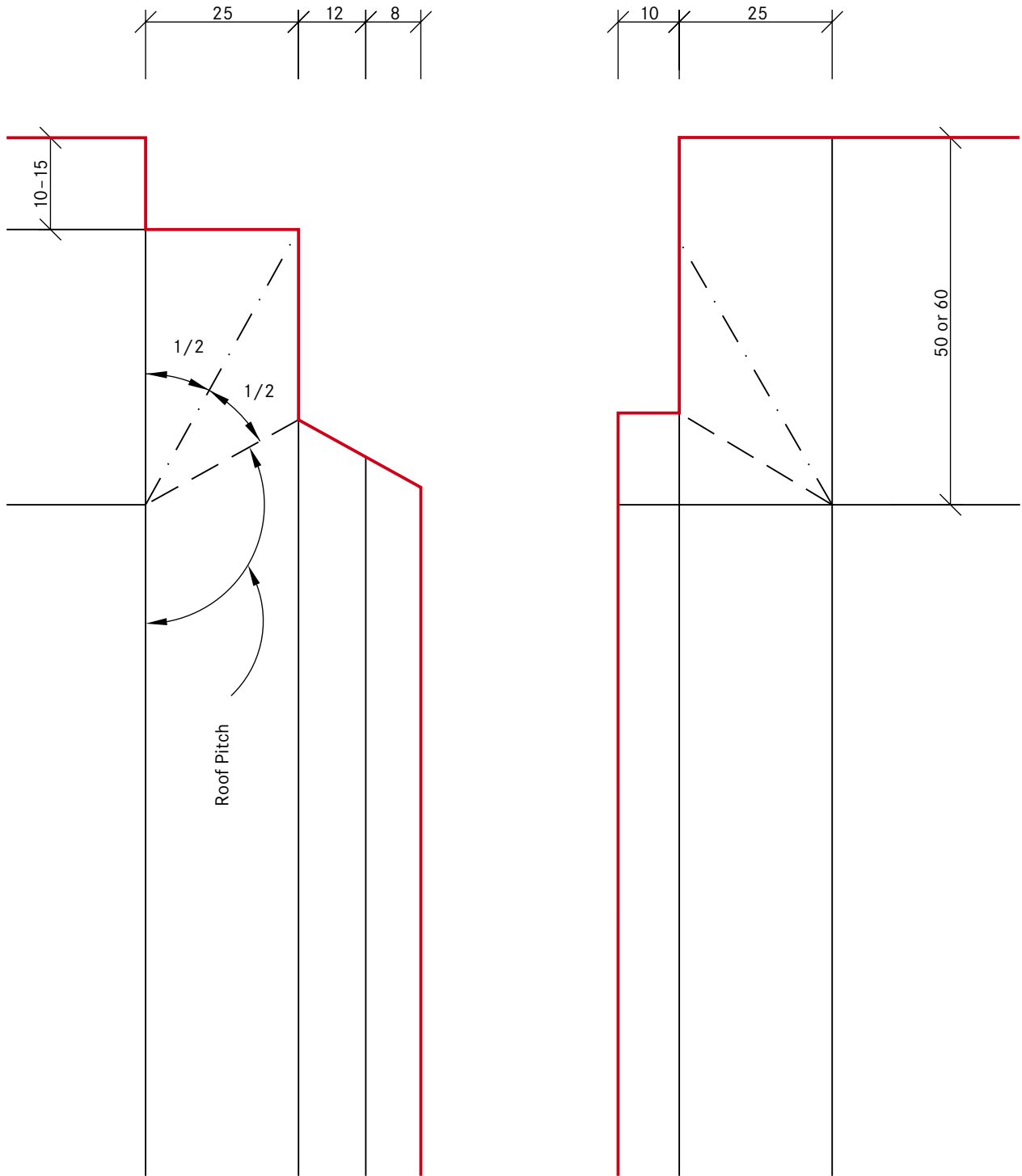

# Straight Dog-Eared Upstand, Preformed

This type of seam is necessary in tight places where a lack of space prevents the use of tools, such as when working up against a ridge batten.

1

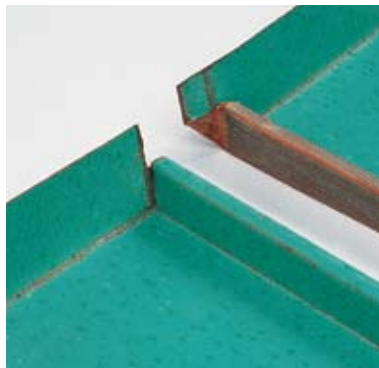

The end of the pre-profiled tray is scribed and notched. The head end of the tray is folded to fit the pitch of the roof.

2

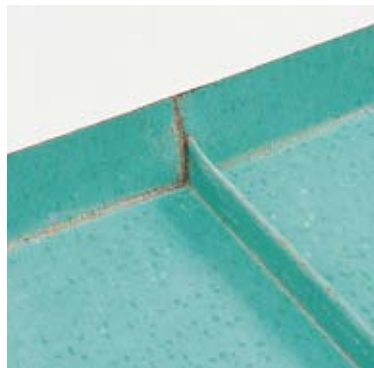

Then the trays are hooked together and seamed.

**Straight dog-eared upstand  
made of TECU® copper**

**Scale 1:1**

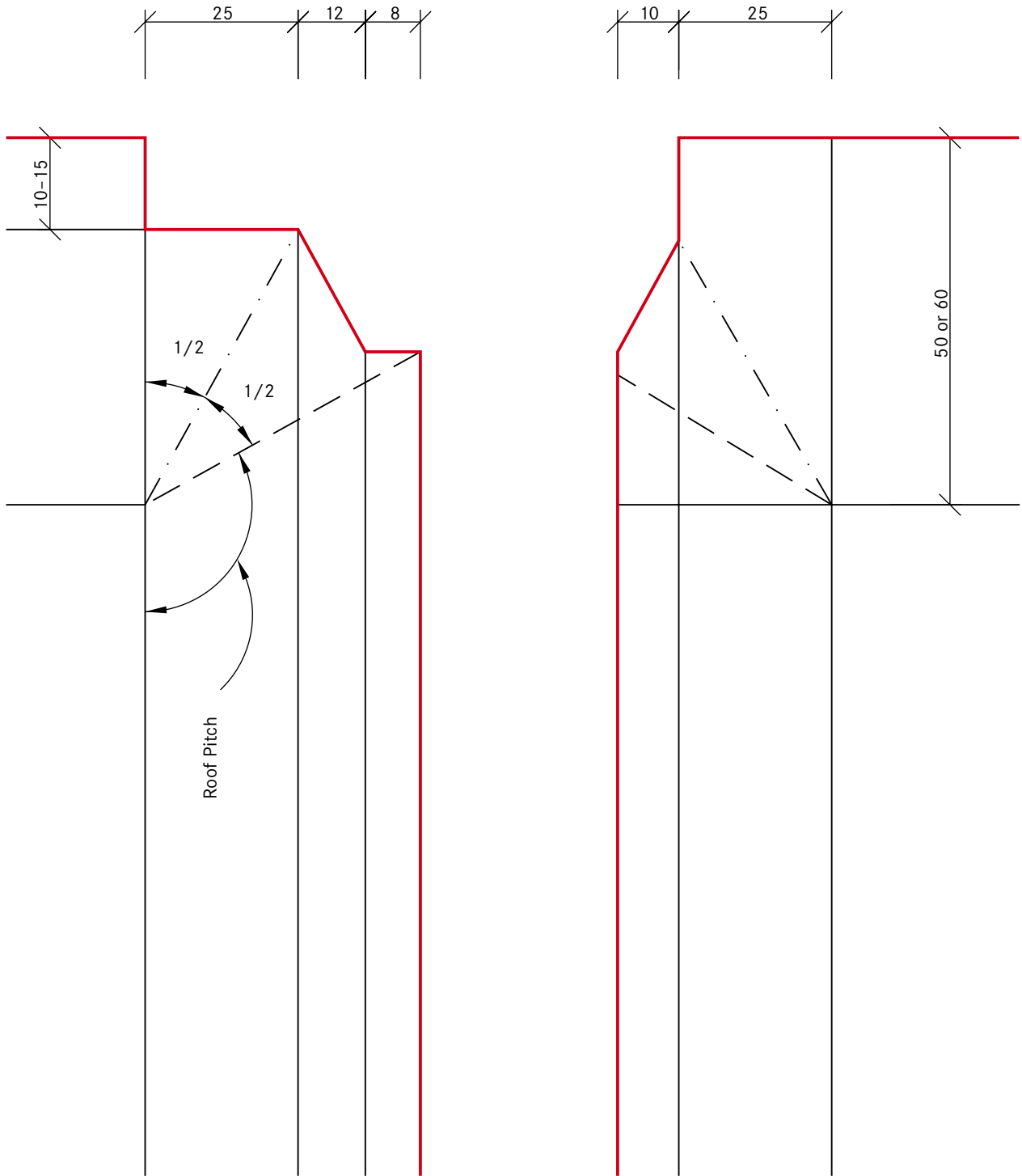



# Straight Dog-Eared Upstand

The following sequence of photos depicts the most commonly used method of upstand construction. It allows the installer to cut the trays to individual lengths on site in order to fit them to specific dimensional tolerances.

1

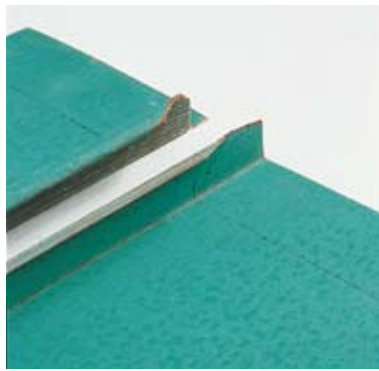

The ends of the trays are cut to size, then scribed and cut.

2

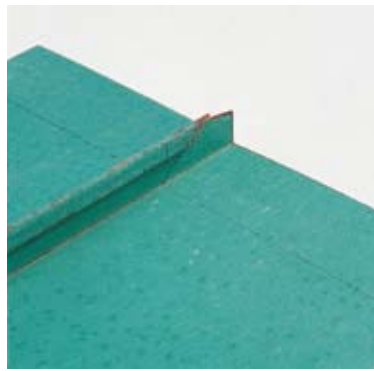

The trays are double-seamed up to the head end.

3



The ends of the trays are erected with straight flat-nosed pliers.

4



The protruding standing seam is bent parallel to the ridge with cranked seaming pliers.

5



On the reverse side, the angled brace is pressed flat with a timber and hammer.

6





*The names of the tools may vary between regions or countries.*

# Tools

Before profiling and seaming machines became common tools in the plumbing and roofing field, all of the work was accomplished with the help of hand tools and smaller brake presses. But despite modernisation and new developments, hand tools are still an important part of modern plumbing and roofing today. The most common tools needed in any plumbing and roofing workshop are displayed here.

- 1 Seaming iron
- 2 Seaming iron
- 3 Sweep seaming iron
- 4 Double seamer for curved seams
- 5 Double seamer
- 6 Unpicking tool
- 7 Angle seamer
- 8 Double seamer
- 9 Eaves folder (first turn)
- 10 Eaves closer (second turn)
- 11 Multi-purpose snips
- 12 Right and left curved eaves snips
- 13 Right and left curved snips
- 14 Pelican snips for long cutting
- 15 Straight snips
- 16 Small straight seaming pliers
- 17 Small cranked seaming pliers
- 18 Cranked seaming pliers 45°
- 19 Cranked seaming pliers 90°
- 20 Straight flat-nosed pliers
- 21 Universal flat-nosed pliers
- 22 Straight large seaming pliers
- 23 Cranked large seaming pliers
- 24 Pliers for frame surrounds
- 25 Large creasing tool (dog ears)
- 26 Scribing compass
- 27 Pitch measurer
- 28 Creasing tool (dog ears)
- 29 Dog earring pliers
- 30 Scribe and angle gauge
- 31 Corner turning tongs
- 32 Sweep seaming hammer
- 33 Long angle
- 34 Plated grips for eaves
- 35 Male grips for eaves
- 36 Male grips for eaves
- 37 Wooden mallet
- 38 Small mallet with interchangeable head
- 39 Hammer
- 40 Copper and leather headed hammer
- 41 Sand-filled head mallet
- 42 Wooden seaming mallet

# TECU® Project Consulting

Tel. +49 (0)5 41 / 3 21-20 00

Fax +49 (0)5 41 / 3 21-21 11

[www.tecu.com](http://www.tecu.com)

[info-tecu@kme.com](mailto:info-tecu@kme.com)



## TECU® Service

KME's TECU® products are made to meet the demands placed on them by all kinds of different constructions. Many of their quality features are a result of close communication with expert customers in the building industry.

TECU® stands for the perfect combination of high quality and full service. As the world's leading processor and refiner of copper and copper alloy products, KME provides its technical advisory service to developers, architects, clients and roofers throughout Europe and beyond.

Information and consultation ensure skilful use of materials, and make the realisation of perfect solutions possible with TECU® products, even for aesthetically demanding applications. The popular reference manual *TECU® Copper: Planning, Designing and Processing*, available now in four languages, is also accessible at the click of a button as a multimedia CD-Rom and through the Internet.

## TECU® Training Center

The aesthetic and economic superiority of copper products from the TECU® product line for architecture and the building industry is fully exploited when the material is used in a qualified manner in accordance with technical requirements.

The TECU® Training Center of KME Germany AG & Co. KG in Osnabrück holds multi-level professional seminars in which theoretical and practical processing techniques are taught at various levels of difficulty. Students apply their skills in practical work on models.

Courses are offered throughout Europe in collaboration with trade organisations and associations. This service is part of TECU® quality offered by KME.

Tel. + 49 (0) 5 41 / 321- 43 23

Fax + 49 (0) 5 41 / 321- 40 30



# TECU® Sizes and Availability

## TECU® Sheets

### TECU® Classic

Format/Thickness	0,5	0,6	0,7	1,0	1,2	1,5	2,0
1000 x 2000		•	•	•		•	•
1000 x 3000		•	•	•		•	•
1250 x 2500		•	•	•		•	•

### TECU® Patina

Format/Thickness	0,5	0,6	0,7	1,0	1,2	1,5	2,0
600 x 2000			•				
600 x 3000			•				
670 x 2000		•	•				
670 x 3000		•	•				
800 x 3000			+				
1000 x 2000		•	•	+	+	+	
1000 x 3000		•	•	•	+	+	

Manually patinated longer sheets available on request

### TECU® Brass

Format/Thickness	0,5	0,6	0,7	1,0	1,2	1,5	2,0
670 x 2000			•				
670 x 3000			•				
1000 x 2000			•	•			
1000 x 3000			•	•			+

Burnishing by KME Architectural Metals GmbH & Co. KG available on request

### TECU® Bronze

Format/Thickness	0,5	0,6	0,7	1,0	1,2	1,5	2,0
670 x 2000			•	•			+
670 x 3000			•	•			+
1000 x 2000			•	•			+
1000 x 3000			•	•			+
1250 x 2500			+	+			+

Burnishing by KME Architectural Metals GmbH & Co. KG available on request

### TECU® Gold

Format/Thickness	0,5	0,6	0,7	1,0	1,2	1,5	2,0
670 x 2000	+		•	•			
670 x 3000	+		•	•			
1000 x 2000			+	+			
1000 x 3000			+	+			

## TECU® Strips

### TECU® Classic

Width/Thickness	0,5	0,6	0,7	1,0	1,5
200		•	•		
250		•	•		
333		•	•		
400		•	•		
500		•	•		
600		•	•		
670		•	•		
800		•	•		
1000		•	•		
1220		•	•		
1250		•	•		

### TECU® Oxid

Width/Thickness	0,5	0,6	0,7	1,0	1,5
500		•	•		
600		•	•		
670		•	•		

### TECU® Zinn

Width/Thickness	0,5	0,6	0,7	1,0	1,5
500		+	+		
600		•	•		
670		•	•		

### TECU® Brass

Width/Thickness	0,5	0,6	0,7	1,0	1,5
670			+	+	
1000			+	+	

### TECU® Bronze

Width/Thickness	0,5	0,6	0,7	1,0	1,5
670			+	+	+
1000			+	+	+
1250			+	+	+

### TECU® Gold

Width/Thickness	0,5	0,6	0,7	1,0	1,5
1000	+		+	+	

- available
- + on request

Other dimensions and availability available on request.  
 Further information: Project Consulting, Tel. +49 541 321-2000  
 All measurements in mm.

**\_punch** (all perforation types)

Formats*	670 x 2000	1000 x 2000
Thickness	1.0/1.2/1.5/2.0	1.0/1.2/1.5/2.0
TECU® Classic	+	+
TECU® Oxid**	+	+
TECU® Patina	+	+
TECU® Zinn***	+	+
TECU® Brass	+	+
TECU® Bronze	+	+
TECU® Gold	+	+

\* Other formats available on request  
 \*\* max. Thickness 1,5  
 \*\*\* max. Thickness 0,7

**\_mesh** (rib mesh)

Formats	on request	on request
Thickness	1.0	1.2
TECU® Classic	+	+
TECU® Oxid	+	+
TECU® Patina	+	+
TECU® Brass	+	+
TECU® Bronze	+	+
TECU® Gold	+	+

**\_flatmesh** (expanded metal)

Formats	1000 x 2000	1000 x 3000
Thickness	0.7/1,0	0,7/1.0
TECU® Classic	+	+
TECU® Patina	+	+

**\_weave** (all strip sizes)

Thickness	1.0
TECU® Classic	+
TECU® Oxid	+
TECU® Patina	+
TECU® Brass	+
TECU® Bronze	+
TECU® Gold	+

**\_shape** (all types)

Formats	670 x 2000/3000	1000 x 2000/3000	1250 x 2000/3000
Thickness	0,7-1.5	0,7-1.5	0,7-1.5
TECU® Classic	+	+	+
TECU® Oxid	+	+	+
TECU® Patina	+	+	+
TECU® Brass	+	+	+
TECU® Gold	+	+	+

**TECU® System Shingles**

Formats	600 x 430	600 x 600
	Rectangular	Square
TECU® Classic	•	•
TECU® Oxid	•	•
TECU® Patina	•	•
TECU® Zinn	•	•
TECU® Brass	+	+
TECU® Bronze	+	+
TECU® Gold	+	+

Manufacture and sale:  
 KME Architectural Metals GmbH & Co. KG

**TECU® System Rhomboids**

Formats	518 x 830	518 x 758
	Sharp	Round
TECU® Classic	•	•
TECU® Oxid	•	•
TECU® Patina	•	•
TECU® Zinn	•	•
TECU® Brass	+	+
TECU® Bronze	+	+
TECU® Gold	+	+

Manufacture and sale:  
 KME Architectural Metals GmbH & Co. KG

**TECU® Façade Tiles**

Format	200 x 200
TECU® Classic	•
TECU® Gold	+

Manufacture and sale:  
 KME Architectural Metals GmbH & Co. KG

**TECU® Bond**

Nominal thickness	4,0
Thickness of copper 0.3 on both surfaces (alternatively 0.5)	
Format 1000 x 3000	
TECU® Bond Classic	•
TECU® Bond Patina	+
TECU® Bond Brass	+
TECU® Bond Gold	+

**TECU® Panels**

Lengths up to 4000 Widths up to 400	
TECU® Classic	•
TECU® Oxid	•
TECU® Patina <sup>1</sup>	•
TECU® Zinn	•
TECU® Brass	•
TECU® Bronze	•
TECU® Gold	•

<sup>1</sup> Lengths up to 3000  
 Manufacture and sale:  
 KME Architectural Metals GmbH & Co. KG

**TECU® Cassettes**

Custom manufacturing	
TECU® Classic	•
TECU® Oxid	•
TECU® Patina	•
TECU® Zinn	•
TECU® Brass	•
TECU® Bronze	•
TECU® Gold	•

Manufacture and sale:  
 KME Architectural Metals GmbH & Co. KG

**TECU® Profiled sheets**

Corrugated and trapezoidal profiles Formats available on request	
TECU® Classic	+
TECU® Oxid	+
TECU® Patina	+
TECU® Zinn	+
TECU® Brass	+
TECU® Bronze	+
TECU® Gold	+

Manufacture and sale:  
 KME Architectural Metals GmbH & Co. KG

**KME Germany GmbH & Co. KG**

*Architectural Solutions*  
Postfach 33 20  
49023 OSNABRÜCK  
Klosterstraße 29  
49074 OSNABRÜCK  
GERMANY  
Fon +49 (0)541 321-2000  
Fax +49 (0)541 321-2111  
www.kme.com  
info-tecu@kme.com

**KME Italy S.p.A.**

*Architectural Solutions*  
Via Morimondo, 26  
Ex Richard Ginori Ed. 01 Int. A5  
20143 MILANO  
ITALY  
Fon +39 02 8914021  
Fax +39 02 89140281  
www.kme.com  
info-tecu-italy@kme.com

**KME France S.A.S.**

*Architectural Solutions*  
11 bis, rue de l'Hôtel de Ville  
92411 COURBEVOIE CEDEX  
FRANCE  
Fon +33 (0)1 47896-849  
Fax +33 (0)1 47896-932  
www.kme.com  
info-tecu-france@kme.com

**KME Spain S.A.**

*Architectural Solutions*  
Ctra. de Sabadell B -140, km5  
Sta. Perpétua de Mogoda  
08130 BARCELONA  
SPAIN  
Fon +34 93 5747090  
Fax +34 93 5747091  
www.kme.com  
info-iberica@kme.com

**KME Yorkshire Limited**

*Architectural Solutions*  
Severn House, Prescott Drive  
Warndon Business Park  
WORCESTER  
WR4 9NE  
UNITED KINGDOM  
Fon +44 (0) 1905 751800  
Fax +44 (0) 1905 751801  
www.kme.com  
info-yct@kme.com

**FRICKE GmbH**

Eichendorffweg 10  
48268 GREVEN  
GERMANY  
Fon +49 (0)2575 309-0  
Fax +49 (0)2575 309-25  
www.kme.com  
info-fricke@kme.com

**KME America Inc.**

1000 Jorie Boulevard, Suite 111  
OAK BROOK, Illinois 60523  
USA  
Fon +1 (0)630 990-2025  
Fax +1 (0)630 990-0258  
www.kme.com  
info-america@kme.com

**KME India PVT. LTD**

2B, Dyavasandra Industrial Area,  
4th Cross, Whitefield Cross Road  
BANGALORE-560048  
INDIA  
Fon +91 96 63 31 47 54  
Fax +91 80 43 58 03 31  
info-india@kme.com

**KME Metals (Shanghai) Trading Ltd.**

Hong Qiao Road 808, Rm. 8612  
200030 Shanghai  
P.R.C.  
CHINA  
Fon +86 21 64478680  
Fax +86 21 64478679  
www.kme.com.cn  
info-china@kme.com

**KME Benelux BVBA**

Multiburo  
Culliganlaan 1B  
1831 DIEGEM  
BELGIUM  
Fon +32 (0) 2 403 11 73  
Fax +32 (0) 2 403 11 69  
www.kme.com  
info-benelux@kme.com

**Architectural Solutions**

**Austria**  
Fon +43 (0) 699 13 62 91 79  
Fax +43 (0) 1 33 40 160  
info-austria@kme.com

**Architectural Solutions**

**Netherlands**  
Fon +31 (0) 6 53 74 38 92  
Fon +31 (0) 78 621 29 91  
info-nl@kme.com

**Architectural Solutions**

**Russia**  
Fon +7 812 232 4042  
Fax +7 12 753 4372  
info-ru@kme.com

**KME Danmark A/S**

Næsbyvej 26  
5000 ODENSE C  
DENMARK  
Fon +45 65 916410  
Fax +45 65 916411  
www.kme.com  
info-dk@kme.com

**Sweden:**

KME Danmark A/S, Sweden  
Box 118  
64723 MARIEFRED  
SWEDEN  
Fon +46 15 910612  
Fax +46 15 910613  
www.kme.com  
info-s@kme.com

**KME Polska Sp. z o.o.**

ul. Wszystkich Swietych 11  
32-650 KETY  
POLAND  
Fon +48 (0)33 841 09 95  
Fax +48 (0)33 845 19 54  
www.kme.com  
info-polska@kme.com

**KME (Suisse) SA**

Binzallee 22  
8055 ZURICH  
SWITZERLAND  
Fon +41 (0)43 3882000  
Fax +41 (0)43 3882001  
www.kme.com  
info-ch@kme.com

**Architectural Solutions**

**Romania**  
Fon +4 0314 148 449  
Fax +4 0314 148 449  
info-ro@kme.com

**Architectural Solutions**

**Czech Republic**  
Fon +420 602 38 99 27  
Fax +420 312 68 03 34  
info-cz@kme.com

**Architectural Solutions**

**Hungary**  
Fon +36 0704243033  
Fax +36 056421657  
info-hu@kme.com

**Architectural Solutions**

**South East Asia**  
Fon +65 63 37 86 71  
Fax +65 67 48 22 34  
info-sg@kme.com



Institut Bauen  
und Umwelt e.V.

® = registered trademark

All changes reserved.  
Owing to limitations in printing technology, the colours reproduced in this brochure should be regarded as approximate equivalents to the colours described.

1113.040.0508